

Processing edges with defined radii by selective laser deburring

Philipp Surrey^{a,*}, Mauritz Möller^a, Walter Haimerl^b, Claus Emmelmann^a,
Markus Heilemann^a, Christian Conrad^a

^aInstitut of Laser and System Technologies (iLAS), Hamburg University of Technology (TUHH), Denickestr. 17, 21073 Hamburg, Germany

^bHAIMERL Lasertechnik GmbH, Mühlstrasse 41, 71229 Leonberg

Abstract

A laser based edge-refinement process for sheet-metal parts is being developed at the Laser Zentrum Nord (LZN). Selective Laser Deburring (SLD) is a wear-free deburring process for several materials with the possibility to define radii and bevels. As a result, SLD will provide an extended degree of automation for the next generation of manufacturing facilities. In this study burrs of laser cut sheet-metal parts are described systematically. Optimized parameters for SLD are investigated as reaction to the described cutting qualities. The edges are remelted using a 5 kW Nd:YAG laser in order to create refined edges with defined radii. The collected data can be used to recommend parameters for industrial laser-deburring processes. Copyright line will appear here.

© 2016 The Authors. Published by Bayerisches Laserzentrum GmbH

Keywords: laser cutting; selective laser deburring; defined radii

1. Introduction

Burrs diminish practicality, safety and aesthetics and therefore have to be removed in most industrial applications (Schäfer and Breuniger 1975). Solely the removal of burrs takes up to 9% of today's production costs (Beier and Nothnagel 2015; Gillespie 2007; Beier 1999), but burrs cause additional costs because of additional man hours or machine breakdowns (Aurich et al. 2009). Deburring is therefore a driving factor in modern production and many different deburring techniques exist for a wide range of applications.

The advantages of deburring by laser radiation have been presented, e.g. precision components can be deburred and an automated deburring is possible (Lee 2000). Some patents exist for laser based deburring processes, but a wide-spread industrial implementation has not yet been reported. The laser deburring process can be fundamentally changed through the heat contribution. Burrs can be remelted, cut, sublimated and oxidized with laser radiation (Schmidt-Sandte 2002). Many approaches focus on the cutting of burrs using high intensity lasers (Lee and Dornfeld 2001; Schmidt-Sandte 2002). In contrast, SLD is a laser deburring process through which the edges and burrs are remelted to defined radii. Fast processing is granted due to movable mirrors and one laser source is able to deburr different materials wear free.

This paper investigates the application of SLD on various laser-cut sheet-metal parts. The process parameters are optimized in order to compete with conventional deburring processes with respect to the process velocity. SLD offers the unique feature to create defined radii of curvature which is also analyzed extensively in this paper. The findings presented can be used to evaluate possibilities and limitations of the SLD process for industrial use.

2. Material

Samples are cut with the laser cutting machine (TruLaser 5030) from aluminum-alloy, mild steel and stainless steel sheets (AlMg3, 1.4301 and S235 respectively) with a thickness of 2 mm, 3 mm and 4 mm. To examine the

* Corresponding author. Tel.: +49-40-484010-624.
E-mail address: philipp.surrey@tuhh.de

cross section of the edges before and after deburring small pieces are cut from the samples, embedded and prepared by standard metallographic methods.

3. SLD set up

A Nd:YAG solid-state laser (TruDisk 5001) is used with a maximum power of 5000 W and a beam quality of 4 mm rad. The laser beam is defocused and positioned by a 3D focusing lens (3D PFO) mounted to a CNC gantry system. The angle of incidence is defined as the angle between the laser beam axis and the sheet surface. In preliminary tests the deburring with an angle of incidence of 45° and 90° is investigated. For the deburring with an incidence angle of 90° it is shown that with the used setup no consistently round edge geometry can be achieved. In contrast, deburring with an incidence angle of 45° leads to consistently round edge geometry and therefore all further tests are performed with the setup sketched in Fig 1 (a).

4. Methods

4.1. Description of burr situation

The burrs on the laser cut sheets are characterized by measuring the edge dimension of four cross sections per sample as illustrated in Fig. 1 (b). The edge dimension a is the dimension in which the actual geometry of the edge varies from the ideal edge geometry. The deburred edges are described quantitatively by measuring the secondary burr height h , the distance between the ideal edge and the secondary burr a_m in X and Z direction ($a_{m;x}$, $a_{m;z}$) and the radius of curvature r at three positions per sample, see Fig 1 (c). The radius of curvature r is defined as “the smallest radius of the cross-sectional contour after deburring measured from the material side” (Schäfer 1975).

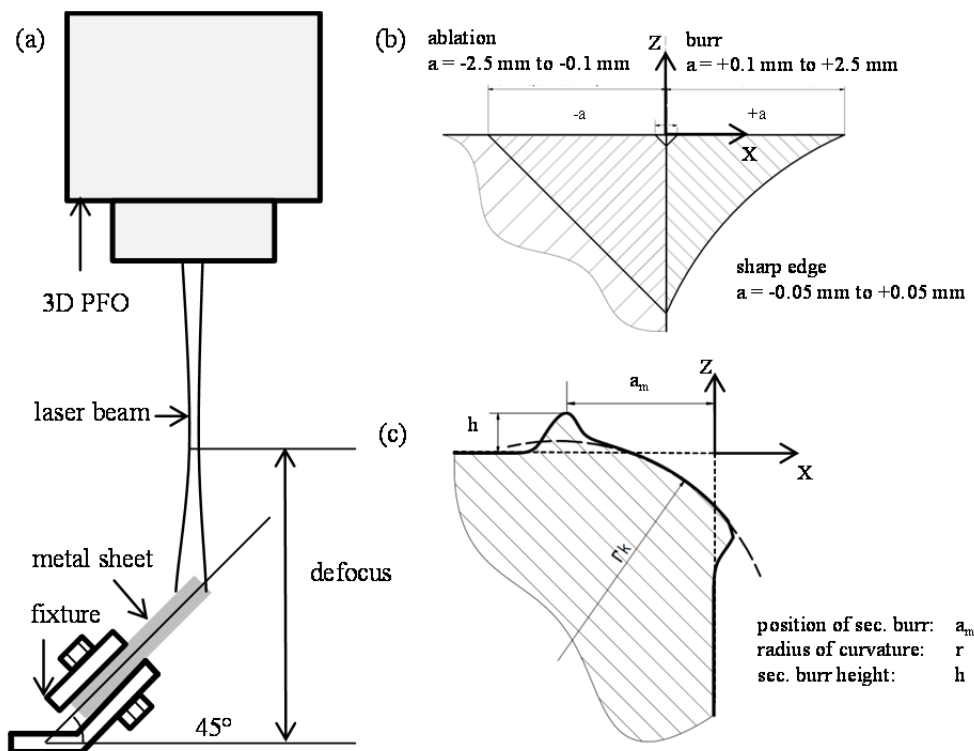

Fig. 1. (a) deburring setup; schematic cross sections of burrs (b) before deburring (DIN ISO 13715) and (c) after deburring (Schmidt-Sandte 2002).

4.2. SLD process parameter study for 3 mm thick stainless steel sheets

A Taguchi test series is run in order to find optimized parameters for the SLD process and to investigate the possibility to form defined radii by controlling the process parameters. The parameter frame is based on preliminary tests and is determined by the process requirement to achieve deburred round edges as fast as possible.

In order to achieve this goal, high deburring velocity from 400 mm s⁻¹ to 600 mm s⁻¹ and a maximum of 5 deburring cycles are tested. The laser power varies in a range from 1000 W to 3000 W. The defocus of the laser beam changes the spot diameter, as listed in Tab. 1. The influence of the defocus to the intensity profile is not further investigated.

Table 1. defocus of the laser beam and the resulting spot diameter.

Defocus in mm	Spot diameter in mm
0	0,65
30	1,60
35	1,80
40	2,05
45	2,30
50	2,55

The upper edge of 3 mm thick stainless steel sheets is deburred with the parameters listed in Tab 2. Additionally, a randomly distributed control factor is implied to evaluate the influence of the parameters. No dependence between the radius of curvature and the control factor is suspected and therefore effects of similar gratitude are considered negligible. The test series is repeated three times to guarantee statistical evidence. Additionally, the parameters are applied once to the lower edge of an identical sheet.

Table 2. process parameters for the Taguchi test series.

Number	Power in W	Defocus in mm	Deburring velocity in mm s ⁻¹	Number of cycles	Control factor
1	1000	30	400	1	1
2	1000	35	450	2	2
3	1000	40	500	3	3
4	1000	45	550	4	4
5	1000	50	600	5	5
6	1500	30	450	3	4
7	1500	35	500	4	5
8	1500	40	550	5	1
9	1500	45	600	1	2
10	1500	50	400	2	3
11	2000	30	500	5	2
12	2000	35	550	1	3
13	2000	40	600	2	4
14	2000	45	400	3	5
15	2000	50	450	4	1
16	2500	30	550	2	5
17	2500	35	600	3	1
18	2500	40	400	4	2
19	2500	45	4500	5	3
20	2500	50	500	1	4
21	3000	30	600	4	3
22	3000	35	400	5	4
23	3000	40	450	1	5
24	3000	45	500	2	1
25	3000	50	550	3	2

The results of the Taguchi test series are used as a first approach to specify SLD parameters for the stainless steel sheets. For the mild steel and aluminum alloy the parameters are adjusted in order to create the same curvature on a 4 mm thick sheet. Subsequently, those parameter sets are applied to 2 mm and 3 mm thick sheets respectively.

The influence of drilled holes on the radius of curvature is investigated at the upper edge of 3 mm thick stainless steel sheets. For this purpose round and oblong holes are machined in a distance from 1 mm to 3 mm to the edge, which is deburred and analyzed subsequently.

5. Results

5.1. Burr geometry after laser cutting

Laser cut sheet material with a thickness up to 3 mm shows high cutting quality. Generally, the burrs are located non-periodically and randomly. After laser cutting the mean edge dimension (mean value of edge dimension in X- and Z-axis) at the upper edge is negative which means no burrs are created, but material is ablated from the edge. In contrast, small burrs are observed at the lower edge as a result of laser cutting. Typical edge cross sections after laser cutting are illustrated in Fig. 2.

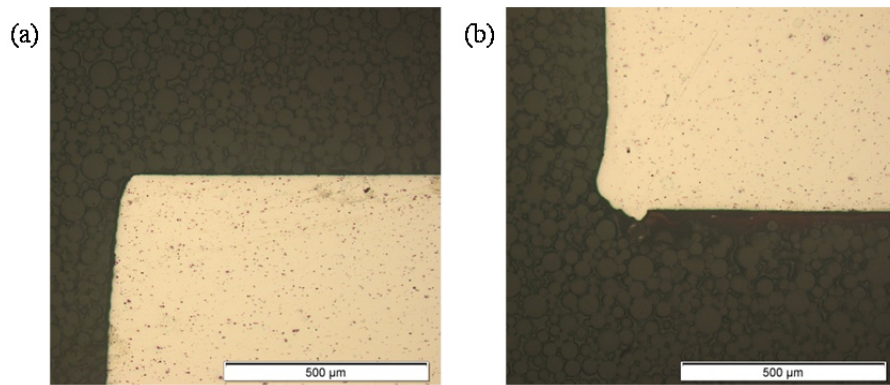

Fig. 2. cross sections of the (a) upper edge and (b) lower edge of 3 mm thick aluminum sheet (AlMg3).

The mean edge dimension of the upper edge is plotted against the sheet thickness in Fig. 3 (a). Thicker sheets need a larger energy input to be cut, which leads to a larger area where the temperature exceeds the melting point. As a result more material is ablated from the upper edge with increasing sheet thickness. This trend is more distinctive for aluminum sheets than it is for steel sheets, because of the higher thermal conductivity.

The mean edge dimension is smaller than 50 μm at the lower edge of sheets with a thickness of 2 mm to 3 mm as illustrated in Fig. 3 (b). Laser cutting leads to sharp edges on the lower sheet surface (DIN ISO 13715). A high cutting quality is also achieved for 4 mm thick steel sheets (edge dimension smaller 50 μm). The cutting quality of aluminum sheets decreases drastically for sheets thicker than 3 mm. The burrs are not located homogenous along the edge and the position of the cross sections is chosen randomly. This leads to a large scatter of the mean edge dimension, because in some cross sections no burrs are observed and in others edge dimensions up to 450 μm are measured. The burrs result from remaining melt which is formed during the laser cutting process and not blown out completely by the process gas. Thicker sheets lead to larger melt volume and therefore to larger burrs.

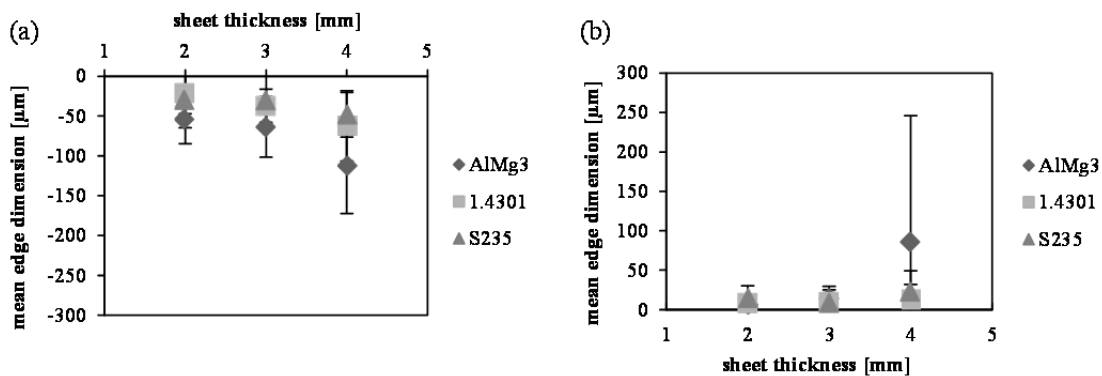

Fig. 3. mean edge dimension at (a) upper edge and (b) lower edge.

6. Selective Laser Deburring

6.1. General observations and effects

The aim of the SLD process is to refine edges, remove small burrs and finally create a curved edge with a defined radius by remelting the edges. Remelting the edges creates secondary burrs on the surfaces. The secondary burrs probably form because of Marangoni currents and rapid solidification of the molten pool. A larger radius of curvature is created by using higher power and lower velocity. In case a large radius of curvature is formed, the melt volume at the edge and the strength of the Marangoni currents increase. As a result the secondary burr height increases as well, as illustrated in Fig. 4.

The appearance (e.g. morphology, color or smoothness) of the edges is not analyzed in detail, but all deburred edges are round and have a burr height of less than 100 μm .

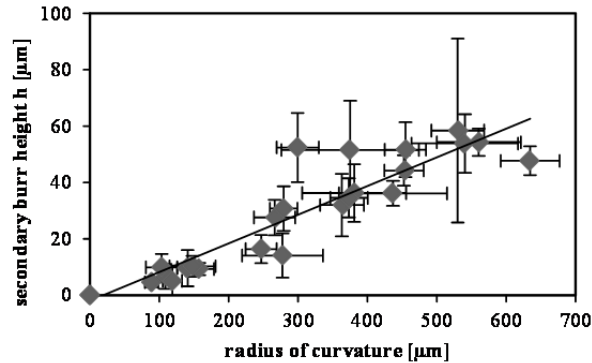

Fig. 4. mean secondary burr height plotted against radius of curvature of deburred edges; 3 mm thick stainless steel sheets; for parameters see Tab. 2.

6.2. Positioning of the laser beam spot

The upper edge of a 3 mm thick stainless steel sheet is deburred with the parameters illustrated in Tab. 3. A visible pilot laser is used to indicate the position of the laser beam. In Fig. 5 (a) and (b) the position of the secondary burr ($a_{m,x}$ and $a_{m,z}$) and the mean secondary burr height are plotted against the position of the pilot laser p . The pilot laser has a smaller spot diameter than the used laser beam, so that the edge is deburred even though the pilot laser is positioned completely on one side of the edge. In those cases a secondary burr is only observed at the surface the pilot laser is positioned on, see Fig. 5 (c) and (e). Between these two extremes the height and the position of the secondary burrs can be determined. A symmetric edge with minimal secondary burrs at both surfaces is achieved when the pilot laser is centered at the edge ($p=0$ mm) as illustrated in Fig. 5 (d).

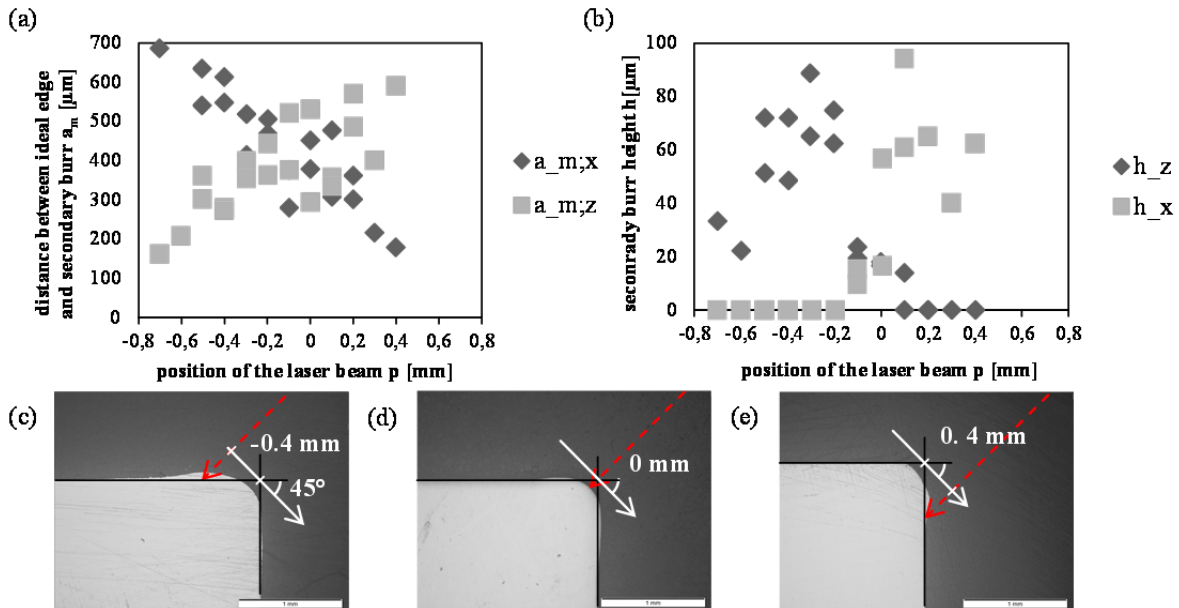

Fig. 5. (a) distance between the ideal edge and the secondary burr (b) secondary burr height plotted against pilot laser position p ; cross section of deburred edges with pilot laser positioned on the (c) sheet surface (-0.4 mm), (d) centered on the edge (0 mm) (e) cut surface (0.4 mm).

6.3. SLD process parameter for 3 mm thick stainless steel sheets

The mean difference between the radii of curvature at the upper and lower edge is $24 \mu\text{m}$. The difference is small, compared to the mean standard deviation of the radius of $35 \mu\text{m}$. Furthermore, the mean absolute edge dimensions of the lower and upper edge, $10 \mu\text{m}$ and $37 \mu\text{m}$ respectively, are more than one magnitude smaller than the radii of curvature, thus, their influence is considered negligible.

The main effect diagrams of the Taguchi test series are illustrated in Fig. 6 (a). The radius of curvature increases linearly with the laser power. In contrast, an increase in deburring velocity results in a decreasing radius of curvature. An increase of the energy input per unit length leads to an expansion of the area in which the temperature exceeds the melting point and a larger volume is remelted. The radius of curvature is therefore proportional to the energy input per unit length (Schmidt-Sandte 2002) as illustrated in Fig 6 (b). Multiple deburring up to 5 times probably increases the radius of curvature due to the increase of energy input as well. Multiple deburring seems to give the edge a smoother appearance, but the trend is not further investigated because the increase of number of cycles lowers the process velocity significantly. Changing the focus from 30 mm to 50 mm shows no distinct effect on the radius of curvature. For all parameters the intensity is smaller than 105 J cm^{-2} and consequently much smaller than the ablation threshold (Schmidt-Sandte 2002). Other laser based material treatments show similar effects, e.g. the low increase of welding penetration with increasing intensity during thermal conduction welding.

The Taguchi test series shows that the radius of curvature can be determined by the process parameters. Based on these results it is suggested to set the radius with the laser beam power and to adjust the other parameters in order to optimize the deburring result. Not one of the investigated parameters leads to bulges and balling as observed by Schmidt-Sandte (Schmidt-Sandte 2002). Nevertheless balling is expected to be one of the main limiting effects for the SLD process. Other expected limitations are larger burrs or the need for larger radii of curvature. Those limitations could be challenged through a two stepped laser deburring process. The first step could involve the ablation of material at the edge with higher laser intensity (Lee 2001) and in the second step the edge could be refined with the presented SLD process.

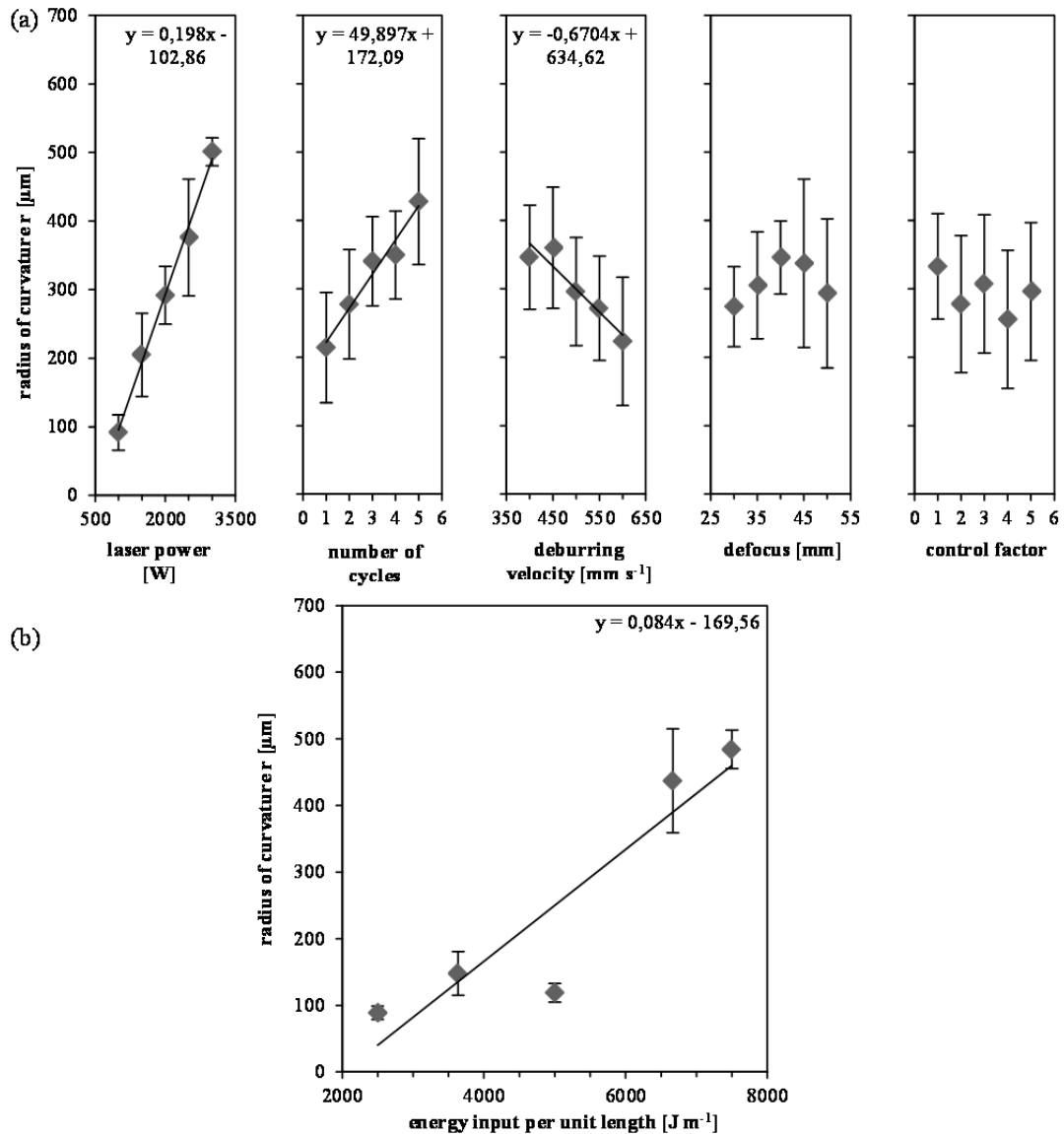

Fig. 6. (a) main effect diagrams of the Taguchi test series; mean radius of curvature with standard error (b) mean radius of curvature with standard deviation plotted against the energy input per unit length for parameters with a number of cycles of 1.

6.4. Deburring of different materials

The gained experience and knowledge about the main influences are used to find deburring parameters for the lower edge of 4 mm thick mild steel and aluminum sheets resulting in the same curvature. The parameters have to be adapted because of the different thermal properties and burr situation of those materials. The parameters are listed in Tab. 3. The aluminum sheet has to be deburred multiple times to compensate the bad cutting quality with the large burrs.

Table 3. process parameters for different materials.

Material	Power in W	Defocus in mm	Deburring velocity in mm s ⁻¹	Number of cycles
AlMg3	3000	40	500	5
1.4301	3000	40	400	1
S235	4000	40	400	1

6.5. Influence of the sheet thickness and other geometries

The parameters listed in Tab. 3 are also applied to the lower edge of sheets with a thickness of 2 mm, 3 mm and 4 mm, see Fig. 7 (a) for resulting radii of curvature. The difference between the radius of curvature of the 2 mm and the 4 mm thick mild steel sheet is 127 μm . At the 2 mm thick sheet there is less material conducting the heat and higher temperatures are estimated due to the heat accumulation. This should lead to a higher melt volume at the 2 mm thick sheet, which would explain the larger radius of curvature. In case of the stainless steel the difference between the radii of curvature of sheets with 2 mm and 4 mm thickness is 58 μm . The influence of the sheet thickness to the radius of curvature shows different magnitudes in mild and stainless steels due to their thermal properties. Mild steels have a higher thermal conductivity but a lower solidus temperature than stainless steels. Generally, the sheet thickness shows a rather indistinctive influence on the radius of curvature e.g. compared to the laser power.

The lower edges of 2 mm and 3 mm thick aluminum sheets have approximately 50% smaller radii of curvature than the steel sheets. The radius of curvature of the 4 mm thick aluminum sheet is approximately as large as the radius of the steel sheets. It is presumed that this effect results from the burr size. The 4 mm thick aluminum sheets have much bigger burrs as illustrated in Fig. 3 (b), thus, the melt volume is larger leading to a large radius of curvature.

The mean radius of curvature at the upper edge of a 3 mm thick stainless steel sheet is plotted against the distance of round and oblong holes to the deburred edge in Fig. 7 (b). The edge is deburred with the optimized parameters listed in Tab. 3. No strong dependency between the distance and the radius of curvature can be determined.

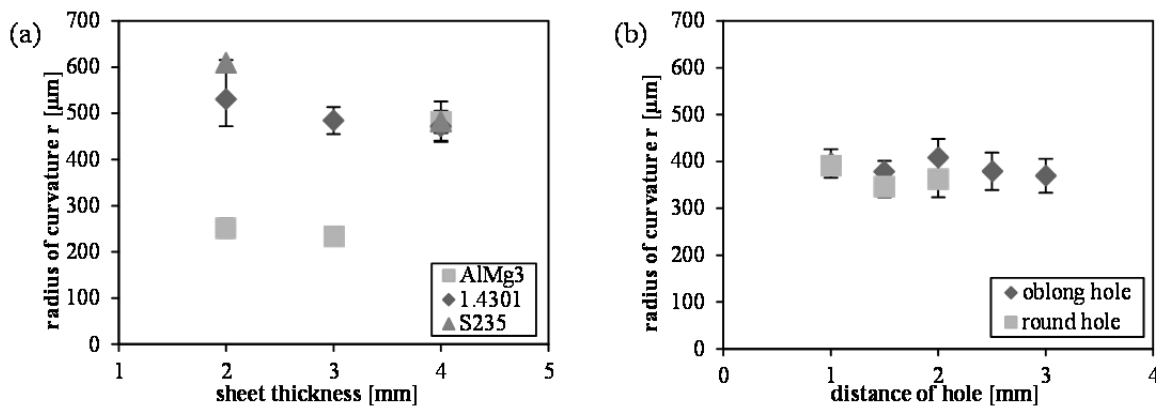

Fig. 7. mean radius of curvature plotted against (a) sheet thickness and (b) distance of holes to the edge.

7. Conclusion

The presented data allow the suggestion that SLD is a possible alternative to conventional deburring methods. The high process velocities as well as the possibility to produce different deburring results with one process are the main advantages. The secondary burrs can be influenced as well as the radius of curvature. With a Taguchi test series the main effects of the SLD process parameter with respect to the radius of curvature are described and a first process parameter frame is specified for 3 mm stainless steel sheets. The parameters cannot be directly used for sheets of different material or thickness, but they can function as a basis for additional parameter studies. No difference between upper and lower edge parameters is expected for steel sheets up to 4 mm thickness because of the high cutting quality. In contrast, the burr size increases significantly for 4 mm thick aluminum sheets and different parameters have to be developed. Furthermore, additional studies are necessary to increase the process quality and productivity and to specify parameters for more applications such as punched sheet material and complex edge geometries.

Acknowledgement

This research was supported by the HAIMERL Lasertechnik GmbH and the LZN Laser Zentrum Nord GmbH. We thank our colleagues who provided insight and expertise that greatly assisted the research. We thank Christian Conrad particularly for assistance with the experimental work and his contribution to this paper.

References

- Schäfer, F., Breuninger, F., 1975. Entgraten. Theorie, Verfahren, Anlagen. Mainz: Krausskopf (Buchreihe Produktionstechnik heute, 14).
- Beier, H.-M., Nothnagel, R., 2015. Praxisbuch Entgrattechnik. Wegweiser zur Gratminimierung und Gratbeseitigung für Konstruktion und Fertigung. München: Hanser.
- Gillespie, L.K., 2007. Mass finishing handbook. New York: Industrial Press.
- Beier, H.-M., 1999. Handbuch Entgrattechnik. Wegweiser zur Gratminimierung und Gratbeseitigung für Konstruktion und Fertigung. München: Hanser.
- Aurich, J. C., Dornfeld, D., Arrazola, P. J., Franke, V., Leitz, L., Min, S., 2009. Burrs—Analysis, control and removal. CIRP Annals - Manufacturing Technology 58, 519–542.
- Lee, S. H., 2000. Analysis of Precision Deburring Using a Laser -An Experimental Study and FEM Simulation. KSME International Journal, 141–151.
- Schmidt-Sandte, T., 2002. Laserstrahlbasierte Entgratverfahren für feinwerktechnische Anwendungen. Technischen Universität Carolo-Wilhelmina zu Braunschweig, Braunschweig.
- Lee, S.H., Dornfeld, D.A., 2001. Precision Laser Deburring. Journal of Manufacturing Science and Engineering 123, 601-608.
- DIN ISO 13715. Technische Zeichnungen – Werkstückkanten mit unbestimmter Form - Begriffe und Zeichnungsangaben. DIN Deutsches Institut für Normung e. V.. 2000-12.